

PLAN VIEW

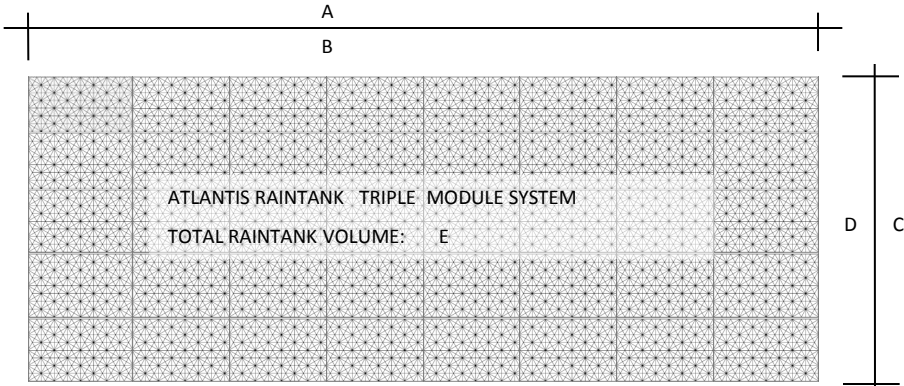

ATLANTIS RAIN TANK UNDERGROUND WATER HARVESTING SYSTEM		
A	RAIN TANK LENGTH	
B	# TANK LONG	
C	RAIN TANK WIDTH	
D	# TANKS WIDE	
E	HARVESTED VOLUME	
F	INLET FLOWLINE	
G	OUTLET FLOWLINE	
H	OPT. WETWELL FLOWLINE	
I	FINISHED GRADE	

PROFILE VIEW

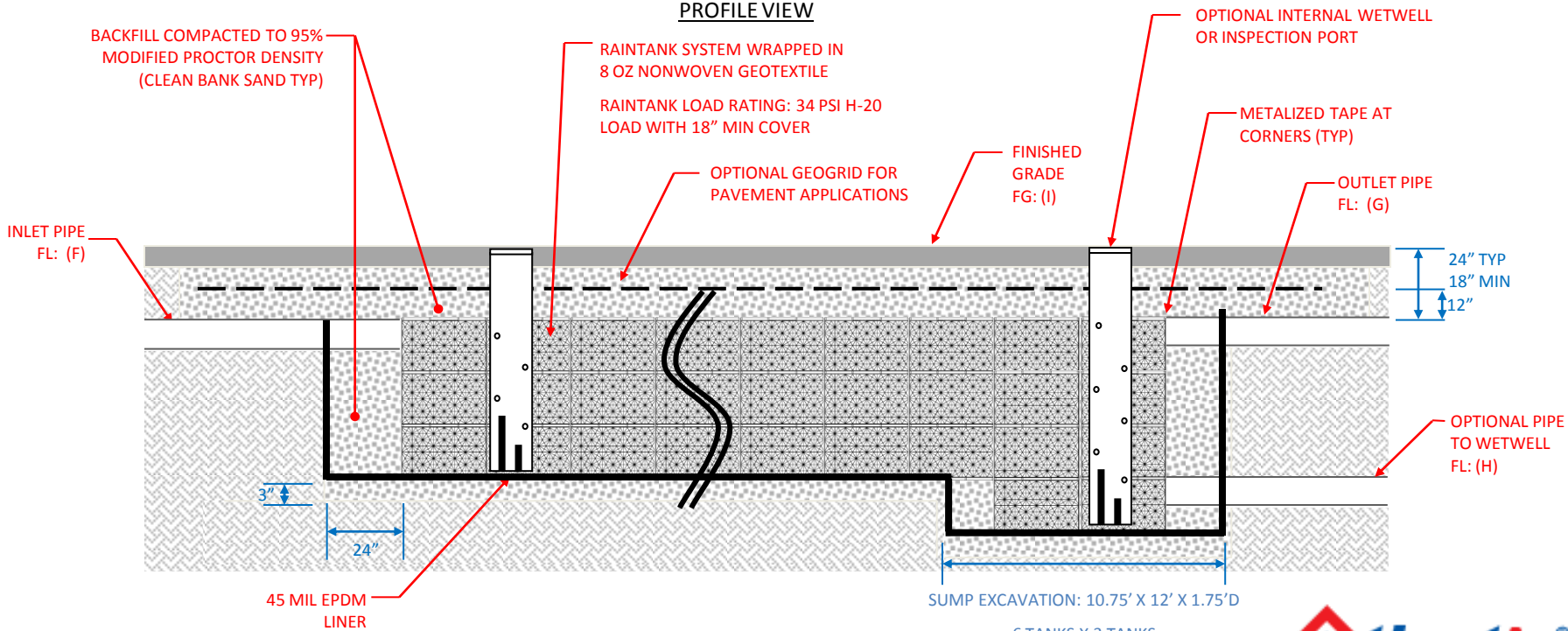

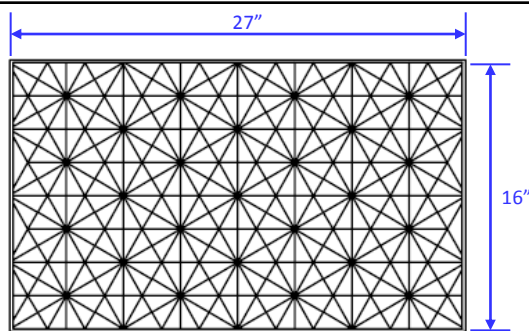

PLAN VIEW

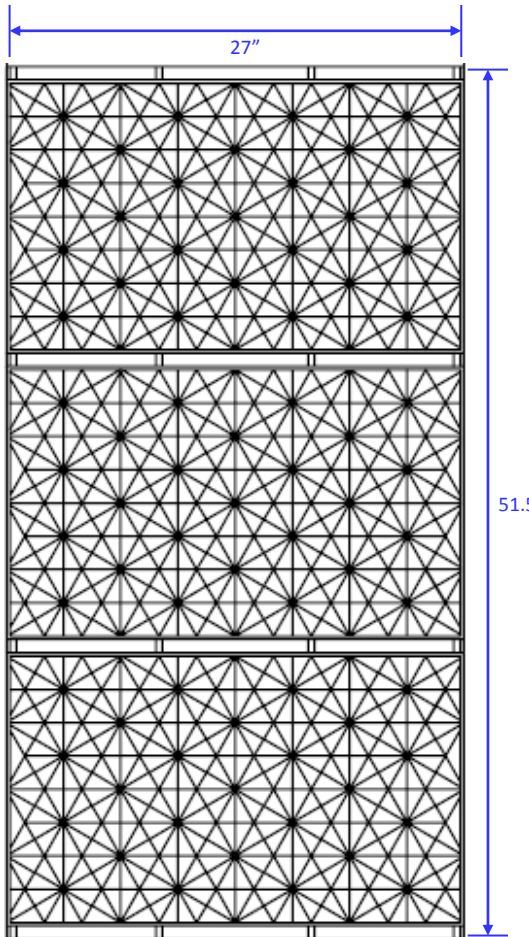

SIDE VIEW

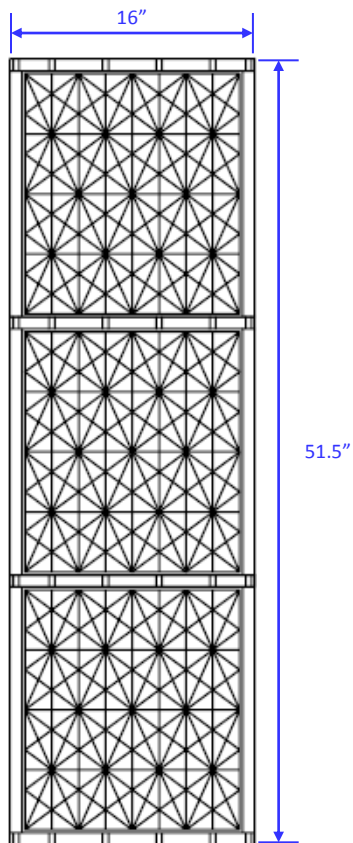

FRONT VIEW

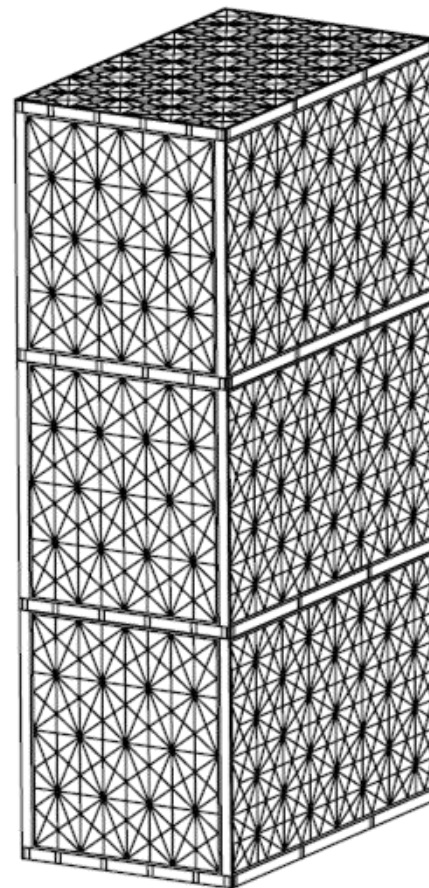

ISOMETRIC VIEW

DIMENSIONS SHOWN ARE NOMINAL,
REFER TO MODULE DATA

MODULE DATA

GEOMETRY:

LENGTH = 26.97IN. (685MM)
 WIDTH = 16.06 IN (408MM)
 HEIGHT = 51.57 IN. (1310MM)
 STORAGE VOLUME = 12.28 CF (348 L)
 VOID INTERNAL VOLUME: 95%
 VOID SURFACE AREA: 90%

LOAD RATING:

34 PSI, (MODULE ONLY)
 H-20 (COVER PER SPEC.)

MATERIAL:

85% RECYCLED
 POLYPROPYLENE

RAINTANK TRIPLE MODULE

PIPE CONNECTION

INLET

8 OZ NONWOVEN GEOTEXTILE
OVERLAPS PIPE BOOT 12"

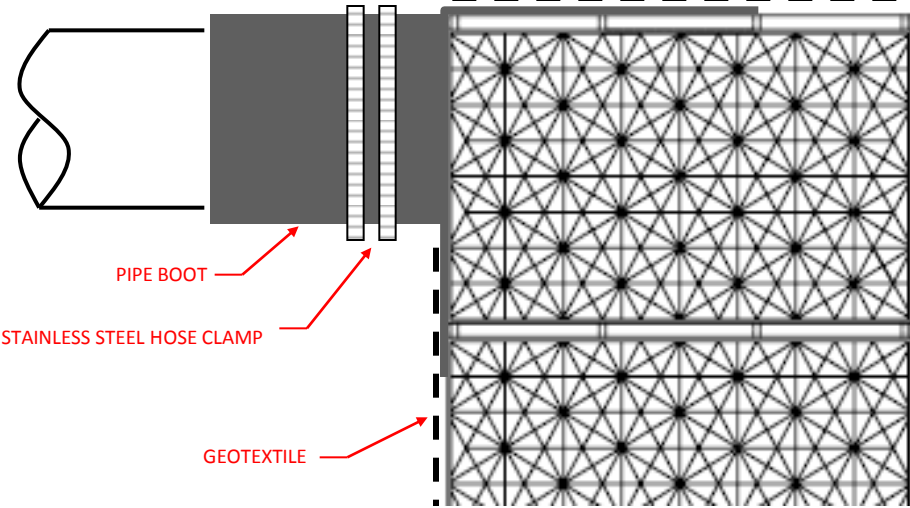

OUTLET

GEOTEXTILE

STAINLESS STEEL HOSE
CLAMP

PIPE BOOT

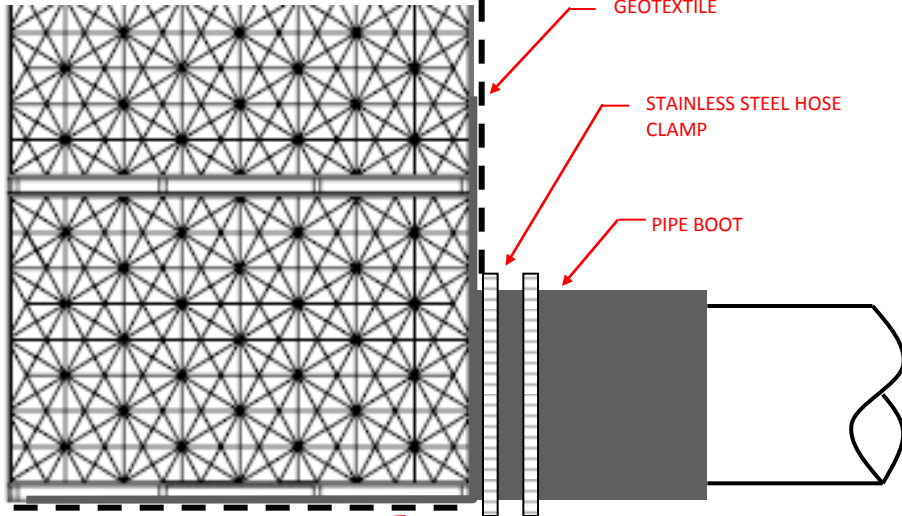

8 OZ NONWOVEN GEOTEXTILE
OVERLAPS PIPE BOOT 12"

PIPE BOOT

FRONT VIEW

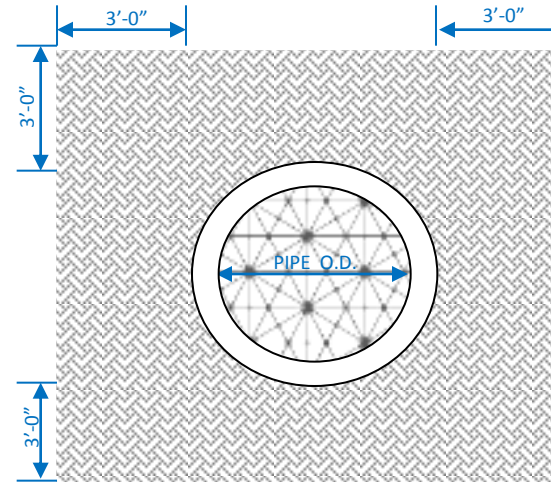

SIDE VIEW

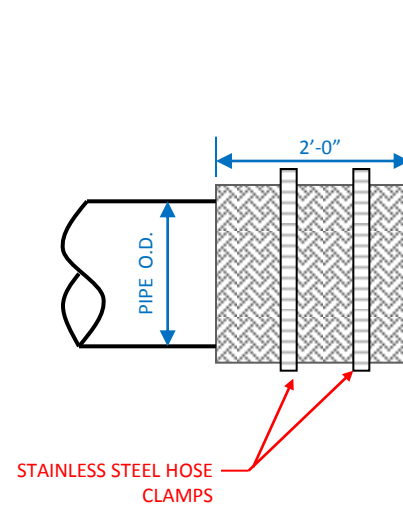

PIPE CONNECTION TO RAIN TANK SYSTEM

MAINTENANCE PORT

THIS PORT IS USED TO PUMP WATER INTO THE SYSTEM AND RESUSPEND ACCUMULATED SEDIMENT SO THAT IT MAY BE PUMPED OUT. MINIMUM REQUIRED MAINTENANCE INCLUDES A QUARTERLY INSPECTION FOR THE FIRST YEAR OF OPERATION AND A YEARLY INSPECTION THEREAFTER. FLUSH AS NEEDED

INSPECTION PORT CAP OR DRAIN CAP MUST HAVE PERFORATIONS TO ALLOW PROPER VENTING

VEGETATED SURFACE

6" DIA. PVC MAINTENANCE PORT

24" TYP
18" MIN

STAINLESS STEEL HOSE CLAMP

GEOTEXTILE

6" - 12" CUT IN
SHADED AREAS

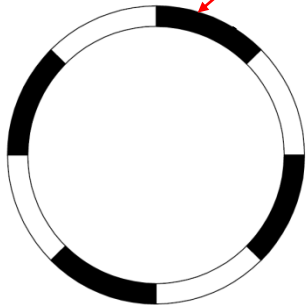

PIPE NOTCHING
PATTERN

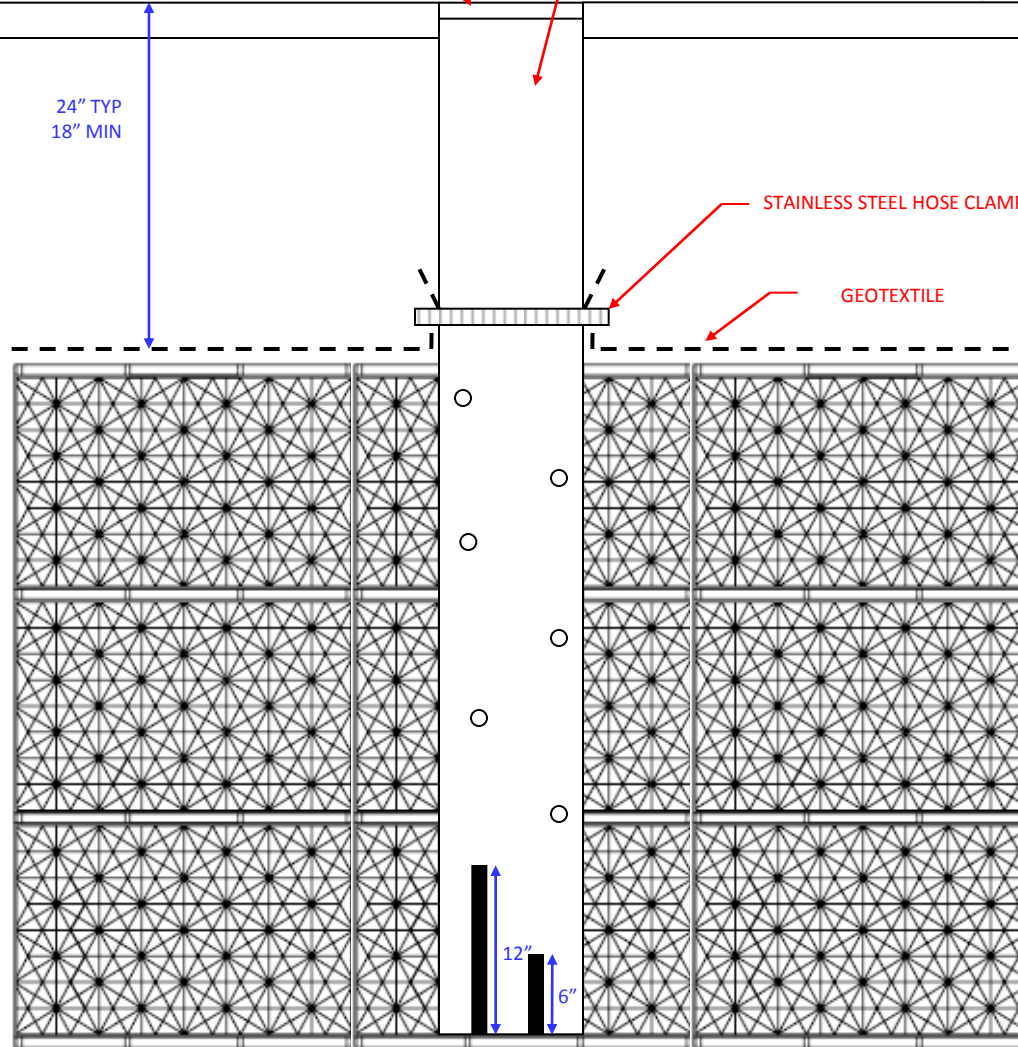

NOTCH BOTTOM OF
PIPE SEE
PATTERN

INSPECTION / VENT PORT

PLAN VIEW

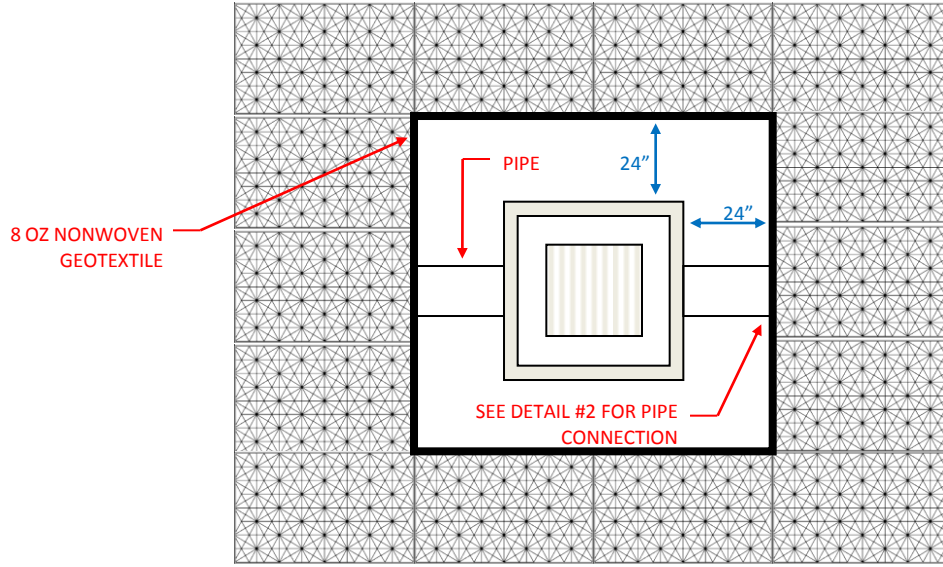

PROFILE VIEW

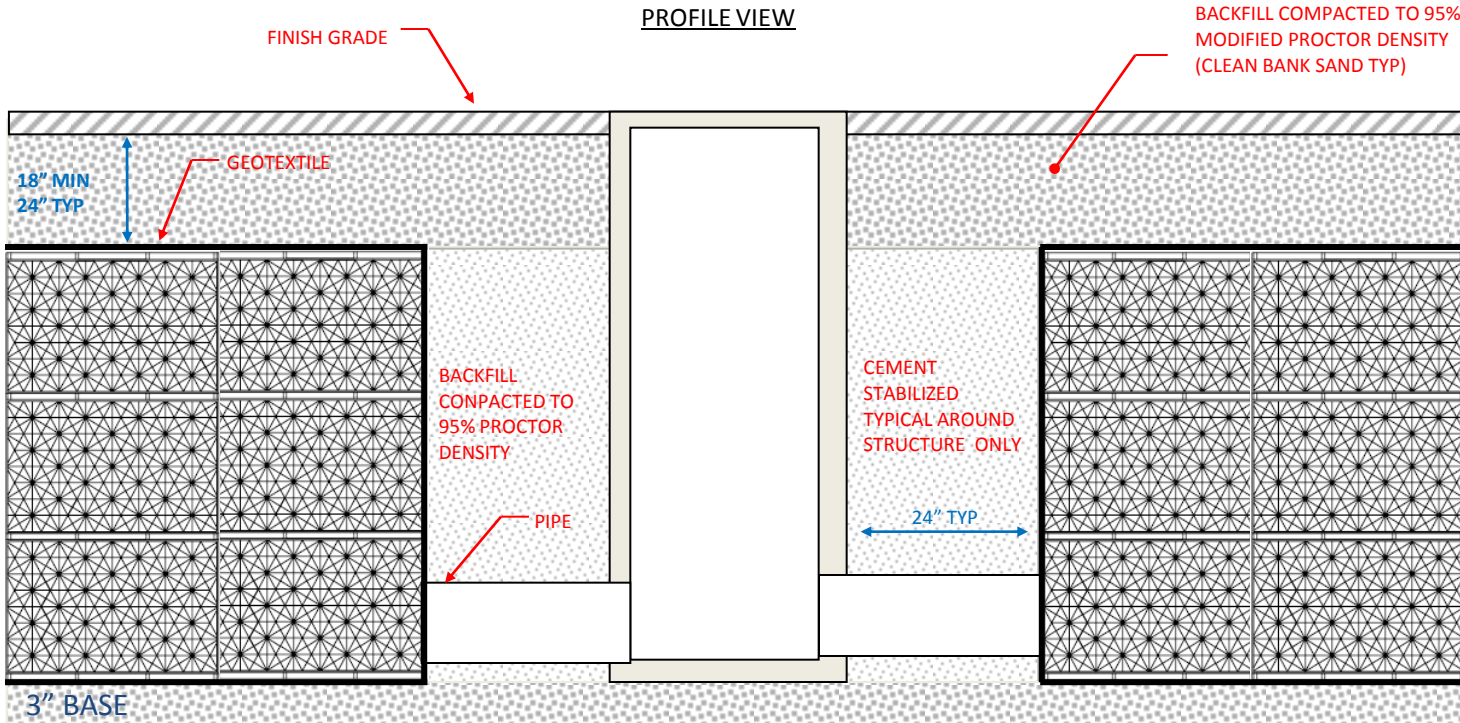

CATCH BASIN IN MIDDLE OF RAIN TANK SYSTEM

GRATE INLET SKIMMER BASKET

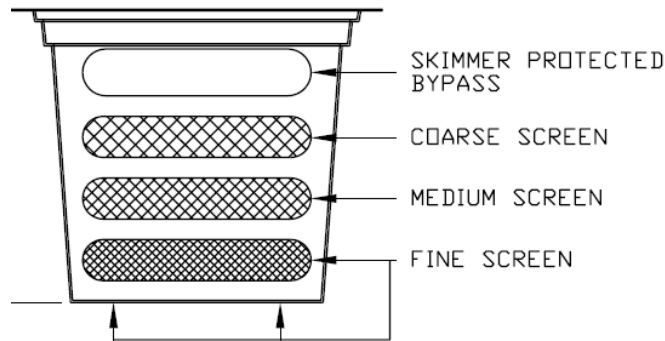
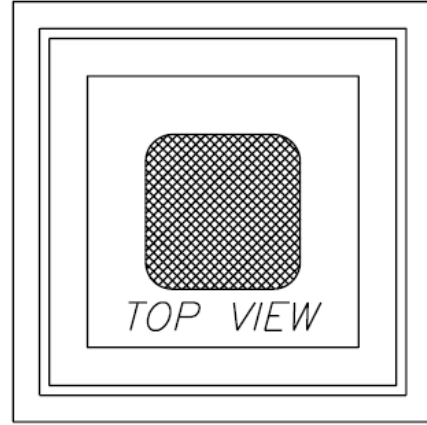
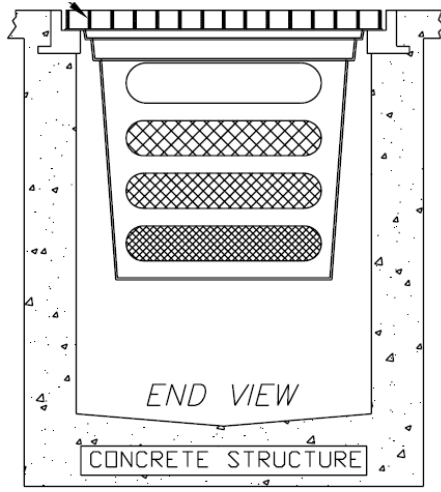

SEE SPECIFICATIONS FOR
MAINTENANCE AND INSTALATION
INSTRUCTIONS

CURB INLET SKIMMER BASKET

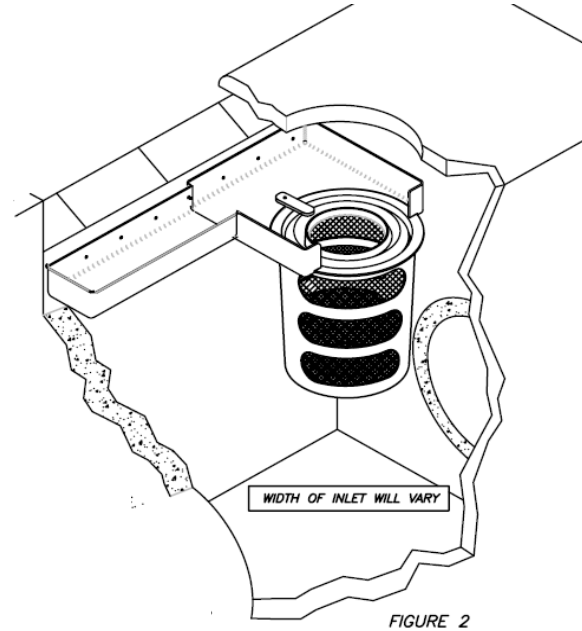
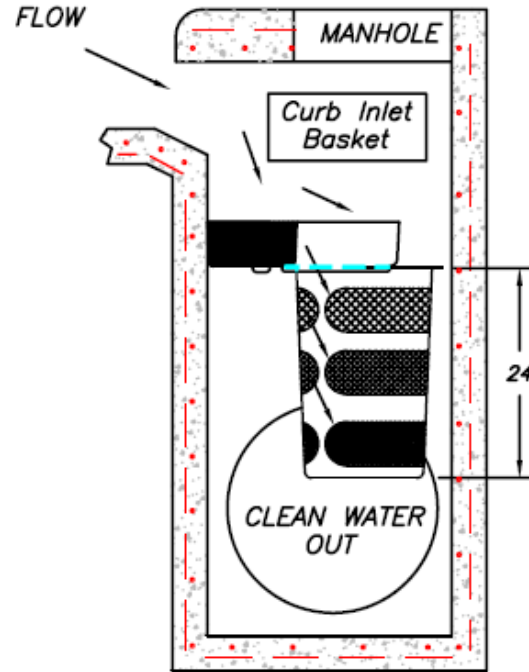

FIGURE 2



SUNTREE TECHNOLOGIES INLET TREATMENT SYSTEM



DETAIL # 6

FOR ADDITIONAL INFORMATION CONTACT CONSTRUCTION ECOSERVICES
P: 832.456.1000 WWW.ECOSYS.COM F: 832.456.1010



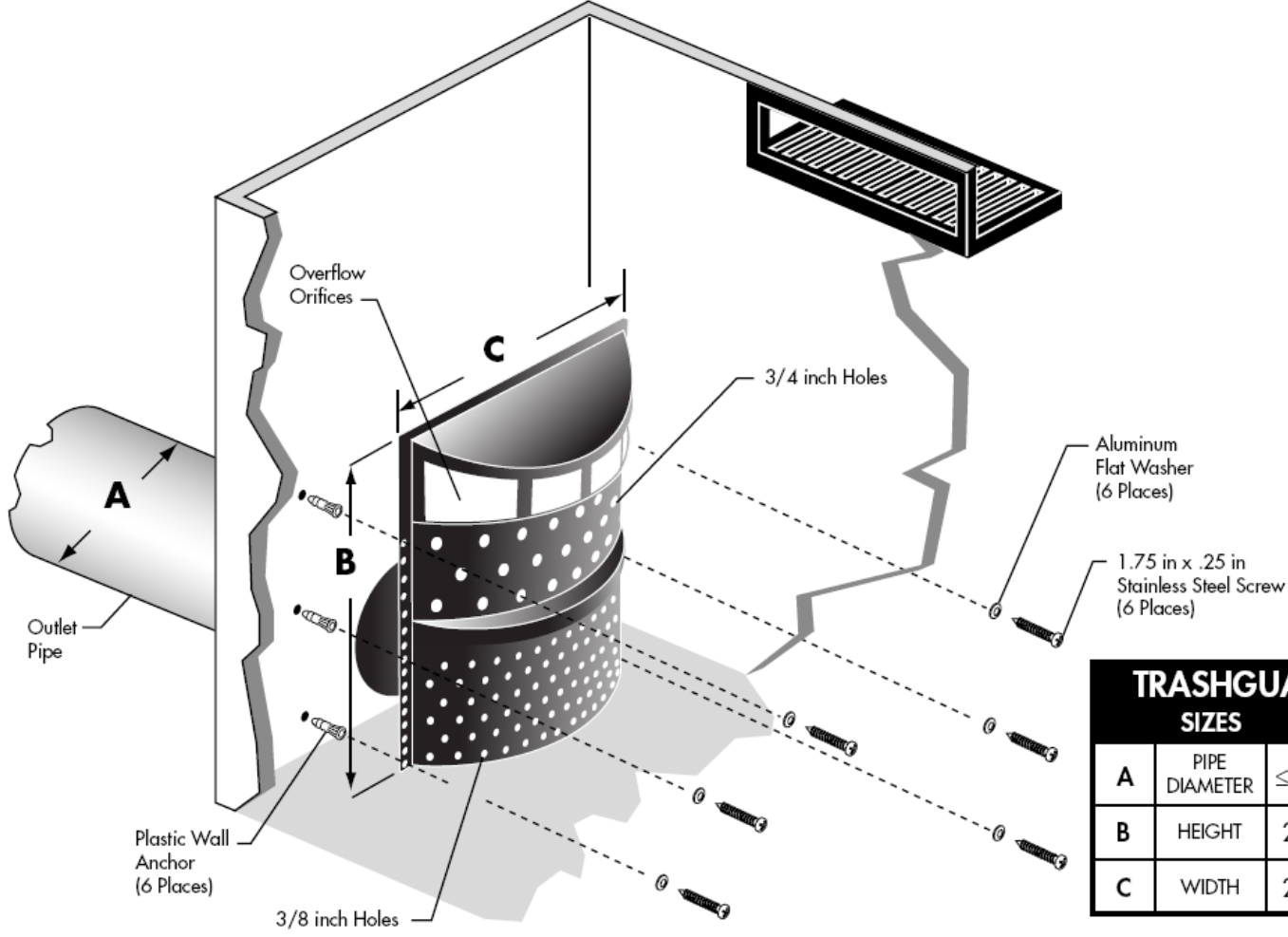

TRASHGUARD DETAILS				
SIZES		23"	28"	34"
A	PIPE DIAMETER	≤ 15"	≤ 18"	≤ 24"
B	HEIGHT	24"	30"	36"
C	WIDTH	23"	28"	34"

TRASH GUARD INLET TREATMENT SYSTEM